

HW100A

WHEELED EXCAVATOR



Gross Power
75 kW (100 hp) at 2000 rpm

Bucket Capacity
0.28 m³

Operating Weight
10.7 – 11.1 t



1 more reason to buy a Hyundai Wheeled Excavator

Introducing the new HW100A, the latest addition to our 6 - 21 tonne A-Series range of wheeled excavators. With a powerful but economical Hyundai Stage V engine and new best-in-class hydraulics, this 10-tonne machine is big on productivity. And, when you add in our high comfort cab featuring a new control cluster and state-of-the-art safety tools like our advanced camera system, there's lots of reasons to buy one.





MORE PRODUCTIVITY & PERFORMANCE

With the large hydraulic capacity of a tool carrier, the ability to work in narrow spaces thanks to boom swing and articulation and unparalleled travel speed of up to 38 km/h, the new HW100A is a compact but powerful machine that's perfectly adaptable to any work site.

Maximum productivity

The HW100A is equipped with the latest generation Hyundai Stage V engine, which delivers greater fuel efficiency but extremely low emissions.



The high-powered Stage V Hyundai engine delivers 100HP and peak torque of 430 Nm.



Maximum efficiency

The HW100A is able to reach higher than 6 meters and has huge lifting capacities thanks to front axle lock and balanced weight distribution. A 2-piece boom option further increases versatility and performance.

Easy controls

All tools are easily operated by proportional hydraulics on the joysticks.

More undercarriage options

Optional blades and outriggers for the front and rear provide more stable working and greater possibilities for different applications.



3 Steering modes

The optional 4-wheel steering increases the machine's manoeuvrability (including crab mode) and reduces its turning circle by 2m.

Twin tyres as standard

Providing maximum traction and increased stability.

New driveline

The new travel motor and powershift transmission control in the driveline provide smoother, more comfortable travel, due to improved hydraulic retarding and gear shifting.

Variable pressure turbocharger

Provides optimal air flow to the engine combustion chamber under all speed and load conditions, for cleaner exhaust gas and improved fuel economy.

Automatic travel speed selection offers either increased torque or high speed



INCREASED FUEL EFFICIENCY



Auto idle

This useful feature starts up to 4 seconds after all controls are returned to neutral, reducing fuel consumption and noise levels in the cabin.

3 Power modes

The operator can choose from 3 working modes for optimal power and reduced fuel consumption in all conditions.

COMFORT & EASE OF USE

The new HW100A has a spacious cab, designed to provide you with the best possible working conditions. Its ergonomic controls and easy-to-view color monitor put you in total control.

More comfort

The HW100A has one of the most spacious cabs in the market, with low noise and vibration levels plus excellent all-round visibility. It has an extra-large door for easy access, fully adjustable, heated air suspension seat and climate control as standard for a more comfortable and productive working day.

King size touchscreen

An extra wide 8" touchscreen provides easy scrolling through the different menus, including power and auxiliary hydraulics settings. It also allows you to connect a Bluetooth device or listen to your favourite radio station.



Efficiency at your fingertips

Precise low-effort joysticks plus, clear convenient controls enable you to work safely and smoothly with minimum effort.

Adjustable steering column **A**

Ensures optimal driving and operation positioning.

1-touch deceleration button

Instantly reduces engine speed to low idle.

Memory function

After setting the hydraulic oil flow, several different work tools can be stored in the display for convenient recall.





 **365 DAYS**
COMFORT

Proportional thumb switches >

Positioned on the joysticks and can be mounted horizontally or vertically to suit the operator.

Proportional auxiliary flow

Provides efficient, precision control when using attachments.



Control your way

The operator can adjust the ergonomic seat and joystick console separately to suit themselves and have control of the boom swing from the joystick.

Cab mounted suspension system

Dampens high vibrations and provides outstanding protection against impact.

MORE SAFETY

With multiple safety features and unrivalled visibility from the cab, the new HW100A offers the ultimate in site and operator safety.



◀ Safety as standard

Standard cab and boom lights (LED as an option) and large side mirrors improve all-round visibility day and night. Other standard safety features include: automatic overheating alarm warning, low oil pressure sensor and engine emergency cut-off switch.



▶ ISO-Certified safety

The state-of-the-art ROPS cab is pressurised and ISO-certified for your safety.

Seat belt warning alarm

If the seat belt is not buckled when the ignition key is turned, an alarm is sounded, along with a continuous visual alert.

More secure transport

4 additional lifting eyes on the undercarriage provide safer transportation.

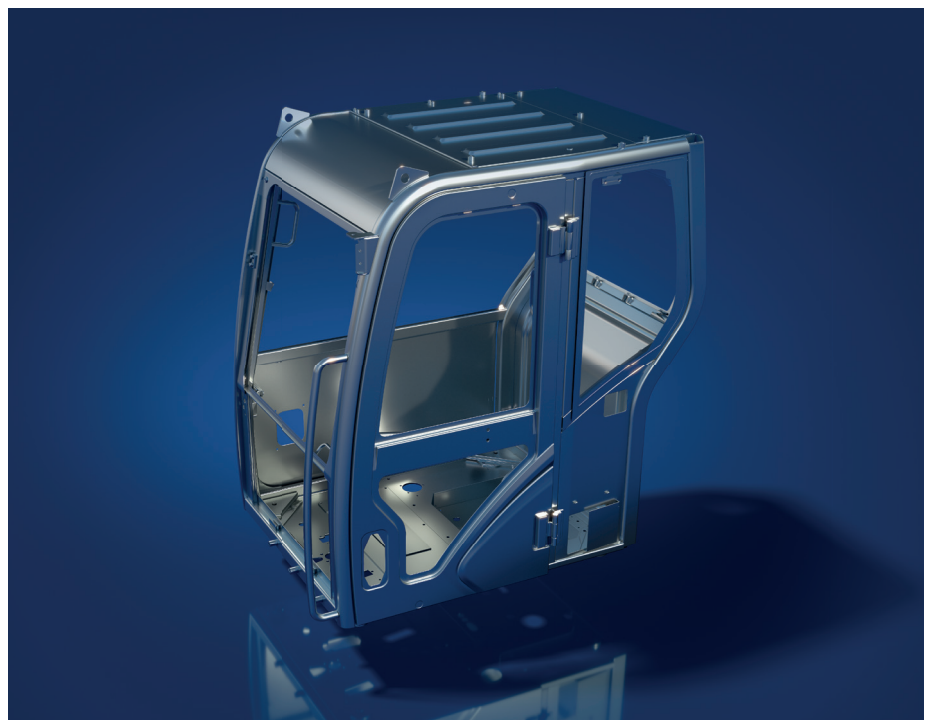

360° visibility with advanced camera system.



360° visibility

A rear-view camera comes as standard while the renowned optional Hyundai AVM (Advanced View Monitoring) system adds to increased safety for machine, operator and the complete job site.



Activate Auto Safety Check

The Auto Safety Lock prevents unintended operation due to the excavator not being controlled solely by the RCV lever.



MORE QUALITY & RELIABILITY

With quality components, essential parts protected from damage and a sturdy undercarriage, the HW100A has been designed to be tougher from the ground up.



► Heavy-duty axles

The heavy-duty front axle with automatic or operator-controlled oscillation lock offers wide oscillating and steering angles while the transmission is mounted directly on the rear axle for greater protection and optimum ground clearance.

Less damage

Parts in contact with the ground have been carefully designed to prevent damage while stabiliser pads reduce ground pressure.

► Designed for tough jobs

A rigid, welded frame provides excellent durability while efficient routing of hydraulic lines, transmission and rear differential protection make the undercarriage perfect for wheeled excavator applications. An oscillating axle lock is also available for digging and lifting operations.

More protection **A**

Large, reinforced covers protect the dozer and stabiliser cylinders, while the stabilisers are kept well within the machine envelope. The position of the pins is kept high, to avoid bumping while moving over the ground.



Strengthened boom and arm

Intensive testing combined with thicker material means that both reliability and component life are increased throughout the boom structure. To better protect the base of the arm, reinforced bars have been added while the arm centre and end boss have also been strengthened.



Equipped with its standard two-piece boom and a tiltrotator, the HW100A achieves a maximum of versatility and manoeuvrability.

A



MORE SERVICEABILITY & TELEMATICS

The HX100A is designed to offer simple daily inspections of all major parts and quick, easy maintenance. All filters and the battery are accessible from ground level through extra wide opening cowl doors.

Advanced filtration

A filter-type, high-performance water separator captures moisture in the fuel to reduce impurities, while pre-filters and dual main filters as standard also help minimise fuel system failures.



Advanced disk brake system

The new improved system allows a more efficient braking of the machine, eliminating the rocking effect associated with working on wheels.

Battery cut-off switch

This makes it easy to disconnect the battery during long-term storage.

Long life brakes

A dual multi-disc circuit with sintered metal discs provides extended service life.



Hi MATE

It's convenient, easy and valuable. Hi MATE, Hyundai's remote management system, utilises GPS-satellite technology to provide customers with the highest level of service and product support available.

Increase productivity

By providing information such as service hours, idle time and fuel consumption, Hi MATE saves you money and improves productivity. Service alerts enable better maintenance planning.

Monitor your machines

Hi MATE's real-time location information allows convenient monitoring of your equipment via the Hi MATE website or mobile app.

Improve Security

Protect your equipment from theft or unauthorised usage. Hi MATE's geofencing alerts notify you automatically when a machine leaves a predetermined zone.

ECD (Engine Connected Diagnostics)

ECD provides troubleshooting information as well as tailored servicing. Service technicians are supported with remote diagnostics allowing them to achieve quick resolution rate.

Mobile fleet app

Our Mobile Fleet app provides all the information you need to run your fleet efficiently and economically.



HCE-DT Air allows service technicians to connect to your equipment wirelessly via smartphone and laptop right on site.

Advanced pin and bushing technology

Highly lubricated metal is used for the boom pivot to increase the component's lifetime and lengthen greasing intervals. The bucket pivot has a tailored surface pattern and self-lubricating coating for optimised greasing and more efficient debris removal while ultra-hard, wear-resistant discs and bucket pivot polymer shims increase durability even more.

Durable hydraulic cylinders

High-strength steel piston rods and cylinder bodies are fitted including a shock-absorbing mechanism in all cylinders, for shock-free operation and extended piston life.

Less maintenance & costs

The axles are designed for low maintenance while the Diesel Particulate Filter (DPF) needs no maintenance up to 5000 hours. Oil change intervals have been increased, further reducing owning and operating costs.

Keeping you covered

Hyundai Genuine Parts and accessories are designed to keep your machine running at optimum performance, with 24-hour delivery across our dealer network. Hyundai Standard and Extended Warranty Programmes provide peace of mind and give you full control over your operating costs.



TAKE THE TOUR

Productivity & Efficiency

- Powerful & efficient Hyundai Stage V engine
- Variable pressure Turbocharger
- 3 steering modes
- 3 power modes
- New driveline

Comfort & Ease of Use

- Spacious, low noise cab
- Extra wide 8" touchscreen
- Proportional auxiliary flow
- Cab mounted suspension system
- Adjustable steering column

Safety

- 360° visibility with advanced camera system
- Standard cab and boom lights with LED option
- State-of-the-art ROPS cab
- Seat belt warning alarm

Quality & Reliability

- Rigid, welded frame
- Heavy-duty axles
- Strengthened boom & arm
- Tough undercarriage

Serviceability

- Ground level servicing access
- Advanced disc brake & filter systems
- Low maintenance components
- Durable hydraulic cylinders
- Low maintenance DPF



HW100A SPECIFICATIONS

SPECIFICATIONS	HW100A
ENGINE	
Maker / Model	Hyundai
Type	4 cylinder, water cooled, 4-cycle, turbocharged charge air cooled, direct injection, electronic controlled diesel engine.
Gross Power	75 kW (100 hp) at 2000 rpm
Max. Power	75 kW (100 hp) at 2000 rpm
Peak Torque	430 Nm at 1400 rpm
Displacement	3.4 ℓ

HYDRAULIC SYSTEM	
Advanced Load Sensing System	
MAIN PUMP	
Type	Variable Displacement Axial Piston
Max. flow	200 lpm @ 2000 rpm
TRAVEL PUMP INDEPENDENT CIRCUIT	
Type	Variable Displacement Axial Piston
Max. flow	112 lpm @ 2000 rpm
Aux pumps	Pilot/steer/brake
Type	Gear pumps

* Load Sensing: LUDV (load independent flow sharing)

HYDRAULIC MOTORS		
Travel	Bent-axis piston motor with 2 speed powershift	
Swing	Axial Piston Motor	
RELIEF VALVE SETTING		
Implement circuits	286 kgf/cm ²	
Travel	408 kgf/cm ²	
Swing circuit	255 kgf/cm ²	
Pilot circuit	29 kgf/cm ²	
Service valve	Installed	
HYDRAULIC CYLINDERS		
No. of cylinder bore × stroke	2-piece boom:	2-100 x 410 mm
	Arm:	1-100 x 846 mm
	Bucket:	1-85 x 690 mm
	Dozer blade:	2-100 x 179 mm
	Outriggers:	2-100 x 179 mm
	Adjustable boom:	1-115 x 775 mm
	Boom swing:	1-110 x 684 mm

DRIVES & BREAKS	
4-wheel hydrostatic drive. Constant mesh, helical gear transmission provides 2 forward and reverse travel speeds.	
Max. drawbar pull	4,200 kgf
TRAVEL SPEED	
1st. gear (low/high)	5.4 / 16.9 km/h
2nd. gear (low/high)	12.9 / 37.4 km/h
Gradeability	35° (70 %)
SERVICE BRAKE	
Independent dual brake, front and rear axle full hydraulic power brake. Spring released and hydraulic applied wet type multiple disc brake.	
PARKING BRAKE	
Spring-applied hydraulic released wet disc brake type in transmission.	

CONTROL	
Pilot pressure operated, proportional joysticks, steering wheel and foot pedals for effortless operation.	
Pilot control	Two joysticks with one safety lever (LH): Swing and arm (RH): Boom and bucket (ISO)
Engine throttle	Electric, Dial type
Lights	Two working lights on the boom, one working light on the cabin, plus rear and right side working lights

SPECIFICATIONS	HW100A
AXLE & WHEELS	
Full floating front axle is supported by center pin for oscillation. Oscillation lock (ram lock) function for safe operation. Rear axle is fixed on the lower chassis.	
Twin tyres (standard)	8.25-20-14PR
Single tyres (optional)	500/45-20

SWING SYSTEM	
Swing motor	Fixed displacement radial piston motor
Swing reduction	2-stage planetary gear reduction
Swing bearing	Grease-bathed
Swing brake	Multi-wet disc
Swing speed	10.5 rpm

COOLANT & LUBRICANT CAPACITY	
	liter
Fuel tank	160
Engine coolant	16
Engine oil	12.6
Swing device - gear oil	1.5
Front axle	7.5
Rear axle (4-wheel steer)	8.1 (6.8)
Transmission	1.6
Hydraulic system (including tank)	238
Hydraulic tank	140
DEF/AdBlue®	20

UNDERCARRIAGE	
Rigid, low-stress welded box-section frame, transmission and rear differential protection, heavy duty axles. Dozer blade and outriggers are easily exchangeable through bolt-on design.	
Dozer blade	Parallel-mounted dozer blade to support machine when working, also for levelling and backfilling.
Outrigger	Indicated for max. operation stability when digging and lifting. Can be mounted on front or rear.

OPERATING WEIGHT		
Machine with articulated boom (1890 mm 1st boom + 1880 mm 2nd boom), 2250 mm arm, 0.28m ³ bucket, 1350 kg counterweight, lubricant, coolant, full fuel tank, hydraulic tank, twin tyres and standard equipment.		
OPERATING WEIGHT		
Steering type	2-Wheel steering	4-Wheel steering
Front grapple bar & rear blade	10682 kg	10788 kg
Front blade & rear outriggers	11073 kg	11179 kg
Four outriggers	11073 kg	11179 kg

AIR CONDITIONING SYSTEM	
The air conditioning system contains fluorinated greenhouse gas refrigerant R134a (Global Warming Potential = 1430). The system contains 0.65 kg of refrigerant representing a CO ₂ equivalent of 0.93 metric tonnes. For more information please refer to the manual.	

HW100A

DIMENSIONS & WORKING RANGE

HW100A WITH TWO-PIECE BOOM

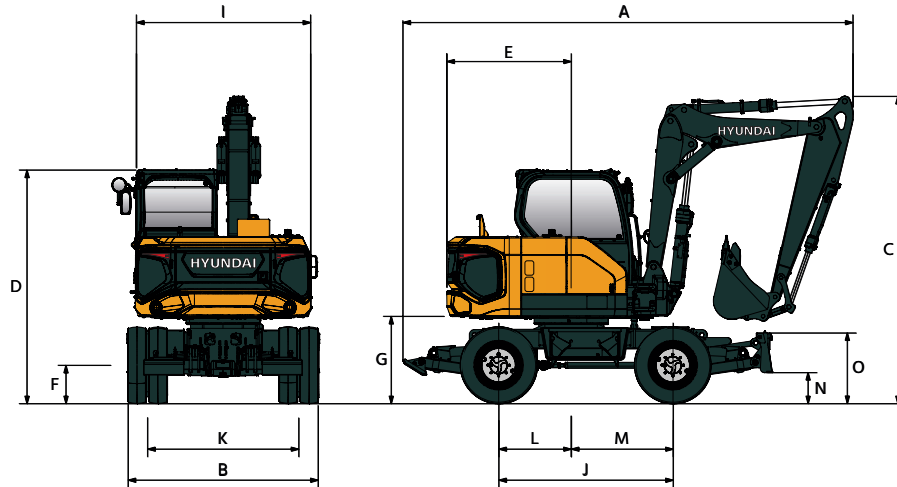

Unit: mm

	Single tyres	Twin tyres	
	Rear dozer	Rear outrigger	
A	Overall length (travel*)	5809	5687
A'	Overall length (transport**)	7319	7281
B	Overall width	2450	2450
C	Overall height (travel*)	3941	3952
D	Overall height (to top of cab)	3000	3011
E	Tail swing radius	1600	1600
F	Minimum ground clearance	317	328
G	Ground clearance of counterweight	1099	1110
L/M	Centre to wheel	932 / 1308	932 / 1308

	Single tyres	Twin tyres	
	Rear dozer	Rear outrigger	
I	Upper structure width	2250	2250
J	Wheel base	2240	2240
K	Tread width	1987	1944
N	Dozer blade - max. lifting height	350	350
	Dozer blade - max. lowering depth	175	175
O	Dozer blade - height	500	500

HW100A WORKING RANGE

Unit: mm

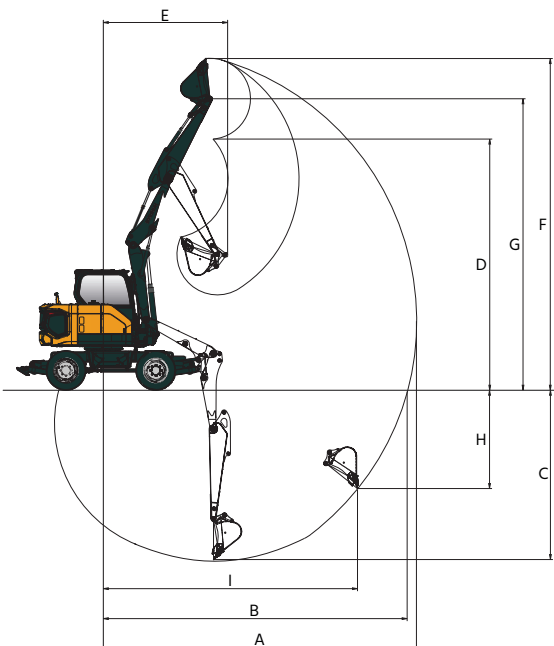

Boom Length	1890 mm lower boom + 1880 mm upper boom	
Arm Length	2250	
Bucket capacity	0.28m ³	
A	Max. Digging Reach	7820
B	Max. digging reach (ground)	7605
C	Max. digging depth	4245
D	Max. dumping height	6250
E	Min. front swing radius	3105
F	Max. digging height	8265
G	Max. bucket pin height	7255
H	Max. vertical wall depth	3670
I	Max. radius vertical	4800
	Boom swing angle (left)	60°
	Boom swing angle (right)	60°











HW100A

LIFTING CAPACITY











 Rating over-front  Rating over-side or 360 degrees

HW100A











2 piece articulated boom (1.89m lower boom + 1.88m upper boom), 2.25m arm, with 1350kg Counterweight, front grapple bar and rear dozer up

Lift-point height m	Lift-point radius								At max. Reach			
	1.5m		3.0m		4.0 m		6.0 m		Capacity		Reach m	
												
6.0m	kg					*2,010	*2,010			*1,880	1,750	4.91
4.5m	kg					*1,920	*1,920	*1,750	1,260	*1,550	1,220	6.10
3.0m	kg					*2,240	1970	*1,770	1,240	*1,470	1,030	6.67
1.5m	kg					*2,640	1800	*1,850	1,180	*1,510	980	6.80
0.0m	kg			*3,110	3,030	*2,680	1700	*1,760	1,140	*1,410	1,020	6.54
-1.5m	kg	*3,360	*3,360	*3,400	3,070	*2,150	1690			*1,170	*1,170	5.81
-3.0m	kg									*700	*700	4.04

2 piece articulated boom (1.89m lower boom + 1.88m upper boom), 2.25m arm, with 1350kg Counterweight, front dozer and rear outrigger down

Lift-point height m	Lift-point radius								At max. Reach			
	1.5m		3.0m		4.0 m		6.0 m		Capacity		Reach m	
												
6.0m	kg					*2,010	*2,010			*1,880	*1,880	4.91
4.5m	kg					*1,920	*1,920	*1,750	1,540	*1,550	1,490	6.10
3.0m	kg					*2,240	*2,240	*1,770	1,520	*1,470	1,270	6.67
1.5m	kg					*5,820	4,890	*4,080	3,220	*3,320	2,670	22.32
0.0m	kg			*3,110	*3,110	*2,680	2,110	*1,760	1,420	*1,410	1,270	6.54
-1.5m	kg	*3,360	*3,360	*3,400	*3,400	*2,150	2,100			*1,170	*1,170	5.81
-3.0m	kg									*700	*700	4.04

2 piece articulated boom (1.89m lower boom + 1.88m upper boom), 2.25m arm, with 1350kg Counterweight, front dozer and rear outrigger up

Lift-point height m	Lift-point radius								At max. Reach			
	1.5m		3.0m		4.0 m		6.0 m		Capacity		Reach m	
												
6.0m	kg					*2,010	*2,010			*1,880	1,820	4.91
4.5m	kg					*1,920	*1,920	*1,750	1,320	*1,550	1,270	6.10
3.0m	kg					*2,240	2,050	*1,770	1,300	*1,470	1,080	6.67
1.5m	kg					*2,640	1,880	1,720	1,240	1,420	1,020	6.80
0.0m	kg			*3,110	*3,110	2,540	1,780	1,680	1,200	*1,410	1,070	6.54
-1.5m	kg	*3,360	*3,360	*3,400	3,210	*2,150	1,770			*1,170	*1,170	5.81
-3.0m	kg									*700	*700	4.04

- Lifting capacities are based on ISO 10567.
- Lifting capacity of the HX A-series does not exceed 75% of tipping load with the machine on firm, level ground or 87% of full hydraulic capacity.
- The Lift-point is bucket pivot mounting pin on the arm (without bucket mass).
- (*) indicates load limited by hydraulic capacity.
- Caution: please be aware of the local regulations and instructions for lifting operations.











HW100A

LIFTING CAPACITY











 Rating over-front  Rating over-side or 360 degrees

HW100A

2 piece articulated boom (1.89m lower boom + 1.88m upper boom), 2.25m arm, with 1350kg Counterweight, front outrigger and rear outrigger down

Lift-point height m		Lift-point radius								At max. Reach		
		1.5m		3.0m		4.0 m		6.0 m		Capacity		Reach m
												
6.0m	kg					*2,010	*2,010			*1,880	*1,880	4.91
4.5m	kg					*1,920	*1,920	*1,750	1,390	*1,550	1,340	6.10
3.0m	kg					*2,240	2,150	*1,770	1,360	*1,470	1,140	6.67
1.5m	kg					*2,640	1,980	*1,850	1,310	*1,510	1,080	6.80
0.0m	kg			*3,110	*3,110	*2,680	1,880	*1,760	1,260	*1,410	1,130	6.54
-1.5m	kg	*3,360	*3,360	*3,400	*3,400	*2,150	1,870			*1,170	*1,170	5.81
-3.0m	kg									*700	*700	4.04

2 piece articulated boom (1.89m lower boom + 1.88m upper boom), 2.25m arm, with 1350kg Counterweight, front outrigger and rear outrigger up

Lift-point height m		Lift-point radius								At max. Reach		
		1.5m		3.0m		4.0 m		6.0 m		Capacity		Reach m
												
6.0m	kg					*2,010	*2,010			*1,880	1,790	4.91
4.5m	kg					*1,920	*1,920	*1,750	1,290	*1,550	1,250	6.10
3.0m	kg					*2,240	2,010	*1,770	1,270	*1,470	1,060	6.67
1.5m	kg					*2,640	1,850	1,760	1,220	1,450	1,000	6.80
0.0m	kg			*3,110	3,110	2,590	1,740	1,710	1,180	*1,410	1,050	6.54
-1.5m	kg	*3,360	*3,360	*3,400	3,140	*2,150	1,730			*1,170	*1,170	5.81
-3.0m	kg									*700	*700	4.04

- Lifting capacities are based on ISO 10567.
- Lifting capacity of the HX A-series does not exceed 75% of tipping load with the machine on firm, level ground or 87% of full hydraulic capacity.
- The Lift-point is bucket pivot mounting pin on the arm (without bucket mass).
- (*) indicates load limited by hydraulic capacity.
- Caution: please be aware of the local regulations and instructions for lifting operations.

HW100A

DIGGING FORCE

HW100A DIGGING FORCE

Boom	Length	mm	1890 + 1880 2-Piece
Arm	Length	mm	2250
Bucket digging force	SAE	kN	51.6
		kgf	5262
	ISO	kN	58.6
		kgf	10489.4
Arm crowd force	SAE	kN	35.6
		kgf	3630
	ISO	kN	36.5
		kgf	3722

HW100A

STANDARD/OPTIONAL EQUIPMENT

ENGINE		STD/OPT
HYUNDAI D34 Engine		•
HYDRAULIC SYSTEM		STD/OPT
Advanced Load Sensing (LUDV)		
Power mode (P, S, E), Work mode (P, W, T)		•
Attachment Flow Control		•
Engine Auto Idle		•
Engine Auto Shutdown		•
20 km/h max. speed		□
37.4 km/h max. speed		•
CABIN & INTERIOR		STD/OPT
ISO Standard cabin		
Parallel type windshield wiper		•
Remote radio On/Off switch		•
DAB radio with Bluetooth and handsfree call system		□
Electric horn		•
All-weather steel cab with 360° visibility		•
Safety glass windows		•
Sliding fold-in front window		•
Sliding side window (LH)		•
Lockable door		•
Hot & cool box		•
Storage compartment		•
Transparent cabin roof-cover		•
Sun visor		•
Door and cab locks, one key		•
Pilot-operated slidable joystick		•
Console box height adjust system		•
Automatic climate control		
Air conditioner & heater		•
Defroster		•
Starting Aid (air grid heater) for cold weather		•
Centralised monitoring		
8" LCD display		•
Engine coolant temperature gauge		•
Max power		•
Auto idle		•
Overload warning with alarm		•
Check Engine		•
Fuel level gauge		•
Hyd. oil temperature gauge		•
Warnings		
Communication error indication		•
Low battery		•
Clock		•
Cabin lights – LED		•
Seat		
Adjustable air suspension seat with heater		•
Cabin ROPS (ISO 12117-2)		
ROPS (Roll Over Protective Structure)		•
FOPS (Falling Object Protective Structure)		•
FOPG (Falling Object Guard)	Front & Top Guard	□

SAFETY		STD/OPT
Battery master switch		•
Rear view camera		•
Rear & Mirror view camera		•
AAVM (Advanced Around View Monitoring)		□
Two working lights on Boom – LED		•
Travel alarm		•
Rear work lamp		•
Beacon lamp		□
Automatic swing brake		•
Safety lock valve for boom & arm cylinder		•
Overload warning device		•
Safety lock valve on bucket cylinder		□
Safety lock valve on dozer blade cylinder		•

ATTACHMENT		STD/OPT
Boom		
2-Piece boom (1890mm + 1880mm)		•
Arm		
2250mm		•

OTHER		STD/OPT
Fuel pre-filter		•
Self-diagnostics system		•
Hi MATE (Remote Management System)		□
Alternator (12V, 140 A)		•
Batteries (12V, 150 Ah)		•
Fuel filler pump		•
Bucket-Clamshell adaptation (3-way valve)		□
Single-acting piping kit (breaker, etc.)		•
Double-acting piping kit (clamshell, etc.)		•
Rotating Piping Kit		□
Quick coupler piping		•
Tool kit		•
Cruise control		•
Lower Frame Toolbox – LH		•

UNDERCARRIAGE		STD
Front grapple rest and rear blade		•
Front blade and rear outrigger		□
Front and rear outrigger		□
2-Wheel steering		•
4-Wheel steering		□
Twin tyres 8.25-20 14PR		•
Single wide tyres 500/45-20		□
Wheel Chock		•
Front and rear mudguards		□

- Standard
- Optional

* Standard and optional equipment may vary. Contact your Hyundai dealer for more information. The machine may vary according to International standards.

* The photos may include attachments and optional equipment that are not available in your area.

* Materials and specifications are subject to change without advance notice.



HD Hyundai Construction Equipment Europe nv, Hyundailaan 4,
3980 Tessenderlo, Belgium. Tel: (32) 14-56-2200 Fax: (32) 14-59-3405

Specifications and design are subject to change without notice.
Pictures of Hyundai Construction Equipment Europe products may
show other than standard equipment.

READY TO CHANGE YOUR WORLD?

Contact your Hyundai dealer.
hyundai-ce.eu/en/dealer-locator

HY-CE-00340. 08/2023. EN. ISSUE 1